



TOYOTA LAND CRUISER

Hardtop, Vinyl Top, Pickup, Station Wagon

Tough! Toyota Land Cruiser 4-wheel Drive Built to take it... And take you where you want to go

Point its nose for the *way-back* country. Out where the pavement ends. Enjoy the adventure of off-roading. Plough through sand, mud, rocks, snow, ice—the Toyota Land Cruiser with 4-wheel drive flattens out the steepest hills, gets you there when others get hung up. Gutsy 6-cylinder 155HP power-plant, fabulous gear combinations of six forward speeds and two reverse, brawny chassis and heavy duty axles, rugged body with vinyl top, all designed to make this versatile vehicle an outstanding performer at all sorts of jobs: construction, forestry, engineering, surveying and exploring. As a recreational vehicle or reliable workhorse, you'll find the Toyota Land Cruiser's unsurpassed. That's why it's so popular all over the world!





It's tough, agile, yet still well-mannered, with a husky 6-cylinder 155HP engine that makes tackling the toughest jobs easy. This Hardtop takes the worst roads, the most impossible conditions in stride. Equally at home getting in to inaccessible construction sites or on weekend family outings or vacation camping trips, it's an ideal combination of brawny body construction, brute power, 4-wheel drive, comfort and safety features. What more could you want? Swing-out type rear door is available as an option.



Hardtop



Vinyl Top

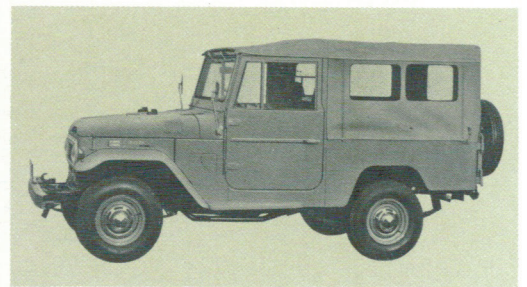

Except for the top material, the Toyota Land Cruiser Hardtop and Vinyl Top are basically the same. However, a larger version is available in the Vinyl Top model (FJ43) with a longer wheelbase (2430 mm. or 95.7 in.), a longer body (4230 mm. or 166.5 in.) and bigger interior dimensions. The Vinyl Top's extremely easy to take off and stow so you can enjoy the fun of topless driving when the weather's right. Room for seven passengers to ride in comfort and safety on vinyl upholstered seats. The instrument panel is designed for ease of operation; all control buttons are picture-symbol identified. And its outstanding durability insures that this vehicle will last for years and years. Optional top-hinged windscreen (push-open type) can be opened from the bottom.

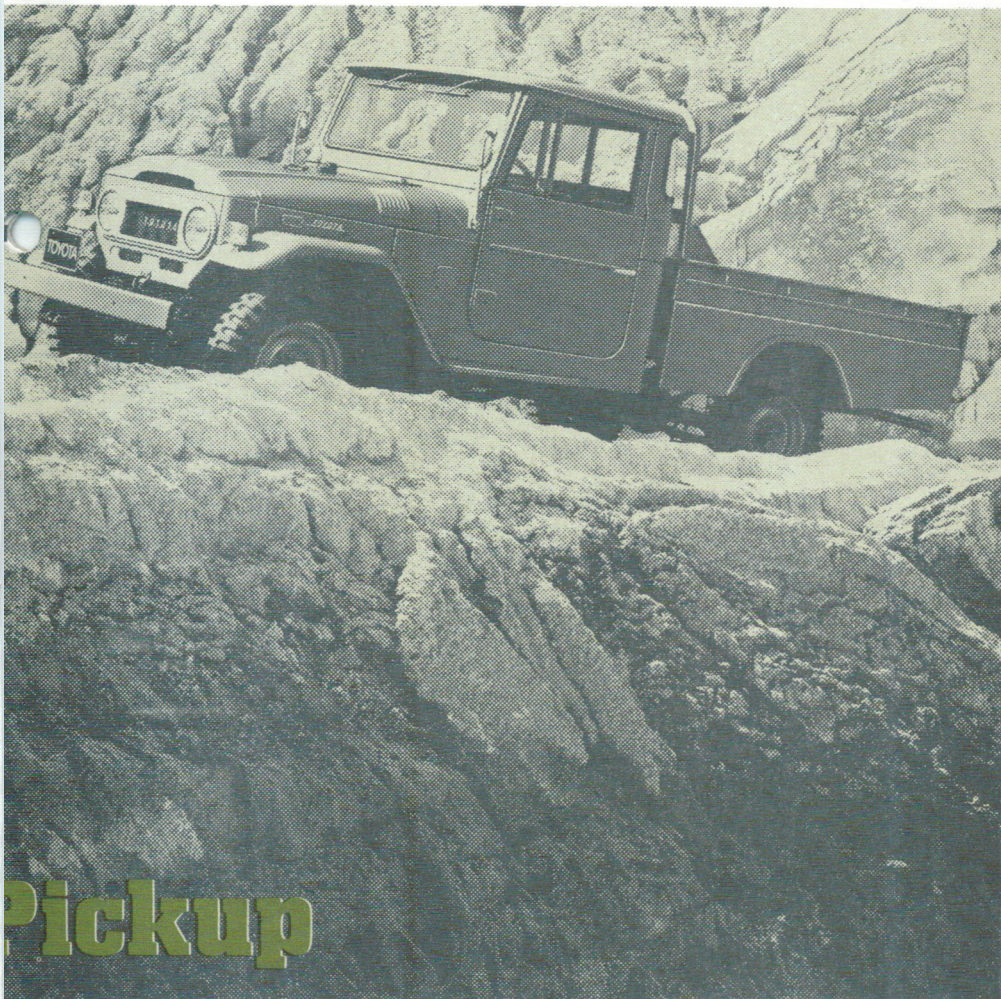

Convenient in size with the power, stamina and utility to outdo anything in its class: that's the Toyota Land Cruiser Pickup. With a husky 6-cylinder 155 HP engine teamed up with 4-wheel drive, it'll carry loads in and out of places other pickups can't go. A large, solid, heavy duty cargo deck lets you haul pipes, logs, lumber, stands up to the worst punishment indefinitely. Why not put a Toyota Land Cruiser Pickup to work and discover its unequalled capabilities.

Interior dimensions of cargo deck: Length, 2135 mm. (84.1 in.); Width, 1590 mm. (62.6 in.); Height, 415 mm. (16.3 in.). Rooftop, doors and rear guard frame are detachable.

Pickup

The comfort and luxury of a family fun car plus the toughness and durability of a commercial vehicle give this one a dual personality. The Toyota Land Cruiser Station Wagon does so many things so well you'll wonder how you ever got along without it. A powerful 6-cylinder 155HP engine lets this Wagon keep up with anything on the road or off it. Spacious cargo area with flat floor and wide opening tailgate makes loading/unloading easier for business or pleasure.

Some outstanding interior features:

- (1) Easy-to-operate instrumentation designed for safety (radio, heater, defroster optional)
- (2) Vinyl upholstered front seats—complete with seatbelt anchorages.

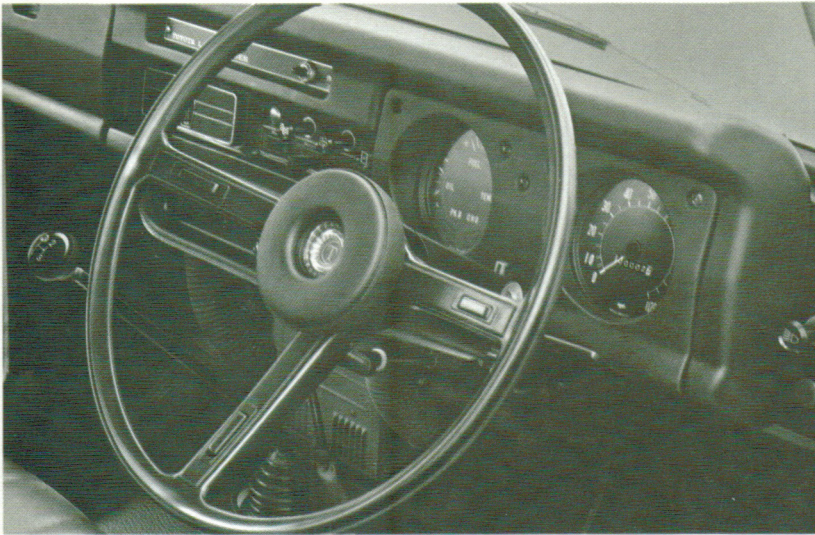

The Land Cruiser Station Wagon's rear window (drop-down type rear gate) can be lowered or raised by flicking a dash switch. A nice little extra at no extra cost.



Station Wagon's rear gate



Station Wagon (Rear gate: drop-down type)



Station Wagon (Rear gates: swing-out type)



Dual speed wiper/washer (option) with glareproof arms.

Hood opens extra wide for easy engine access.

Sun visor (standard equipment) except co-driver's sun visor (option).

Front winch control lever (option).

Front side turn signal. High intensity light makes it easy to see.

Inside rear view mirror, breaks away on impact.

Air outlet (engine room).

Assist grip mounted above glove compartment.

High efficiency heater (option).

Head-rest (option).

Reversing light.

Tail light, Brake light & Rear turn signal.

Reflector.

Bumper.

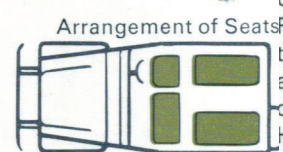

Hardtop (FJ40V)
Vinyl Top (FJ40)

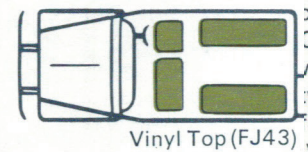

The
an
ea
he

Mo
To
To
Mo

dr
dr
me
Inst
fea
kno
Pict
Har
leat
Tra
and
ope
on t
Fro
and
Star
FJ4
oth
Fro
upr
ang
ri
opa

Flo
tran
and
on t
Han
com
Joo
tran
case
Opt
win
type
ron
Vin
Cato
win

The and Cruiser features all these and more

More comfort, More versatility, More options.

Model with floor-mounted shift/4-wheel drive lever. Four wheel drive may be disengaged merely by pulling a knob. Instrument panel features; easy-to-operate knobs and switches; Picture-identified knobs. Handsome vinyl leatherette seats; Transfer-case shift lever and 4-wheel drive operating lever, mounted on the centre floor. Front seat adjusts fore and aft 140mm. (5.5 in.). Standard on FJ55V and FJ45PB, optional on other models. Front seatbacks lock upright for safety and angle of seatback can be regulated. Seat belts are optional.

Floor mounted 3-speed transmission shift lever and 4-wheel drive lever on the right. Handy glove compartment. Plate on door explains use of transmission, transfer case, 4-wheel drive, etc. Optional top-hinged windscreen (push-open type) can be opened from the bottom (Vinyl Top models only). Catches for tilting windscreen.

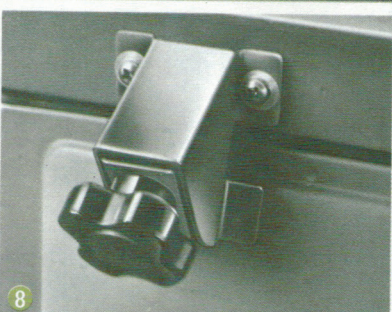
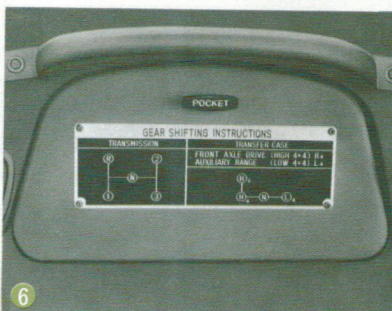
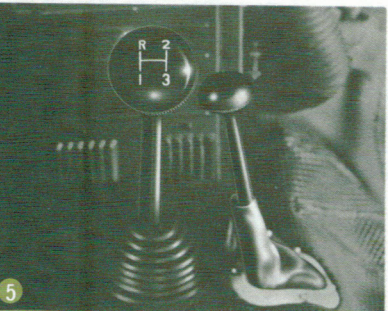
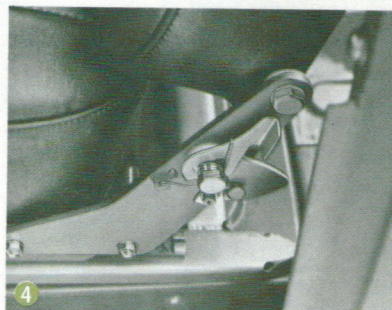
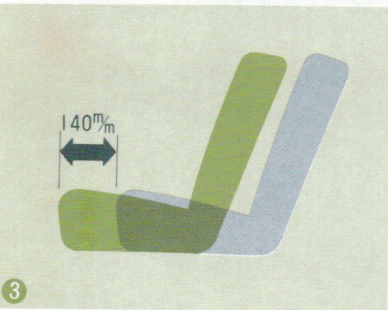
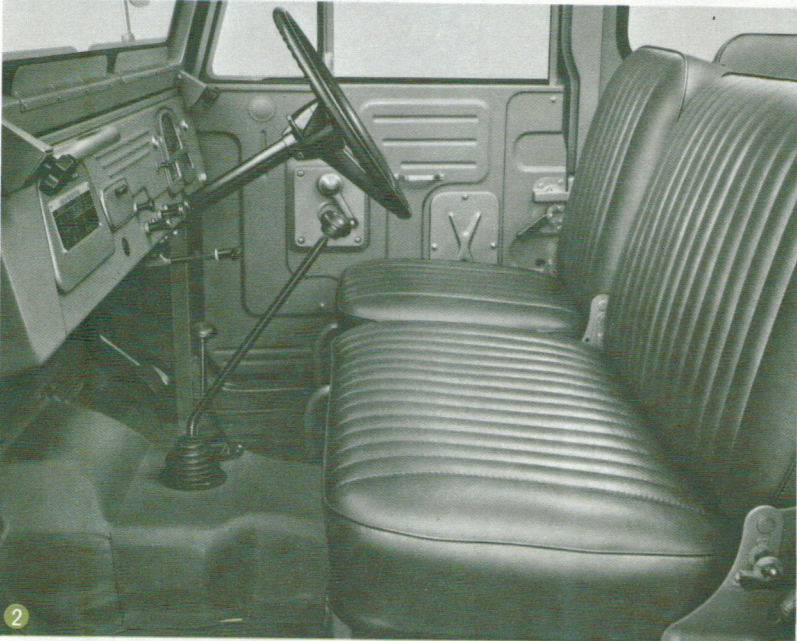
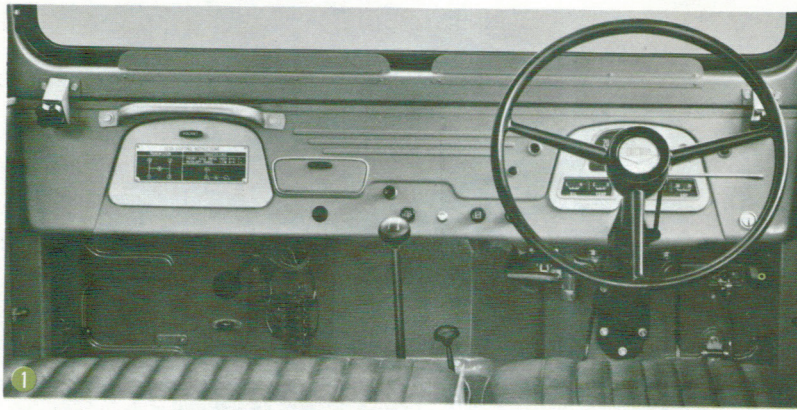

Hardtop.

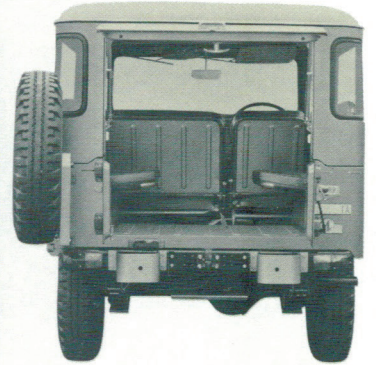

Vinyl Top.

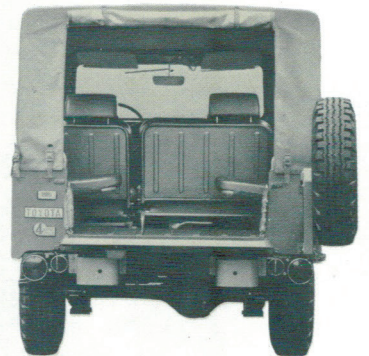

Rear seats (Hardtop model).

Steering worm & sector roller type.
Collapsible steering column with steering lock (option; Station Wagon R.H.D. only).

Tyre type:
Ribbed, Semi-lug, Grip, Snow*, Sand.* (*Snow and Sand tyres are optional.)

Radiator.

Extremely strong durable chassis resists twisting under the worst possible driving conditions.

Propeller shaft.

Differential gear (rear).

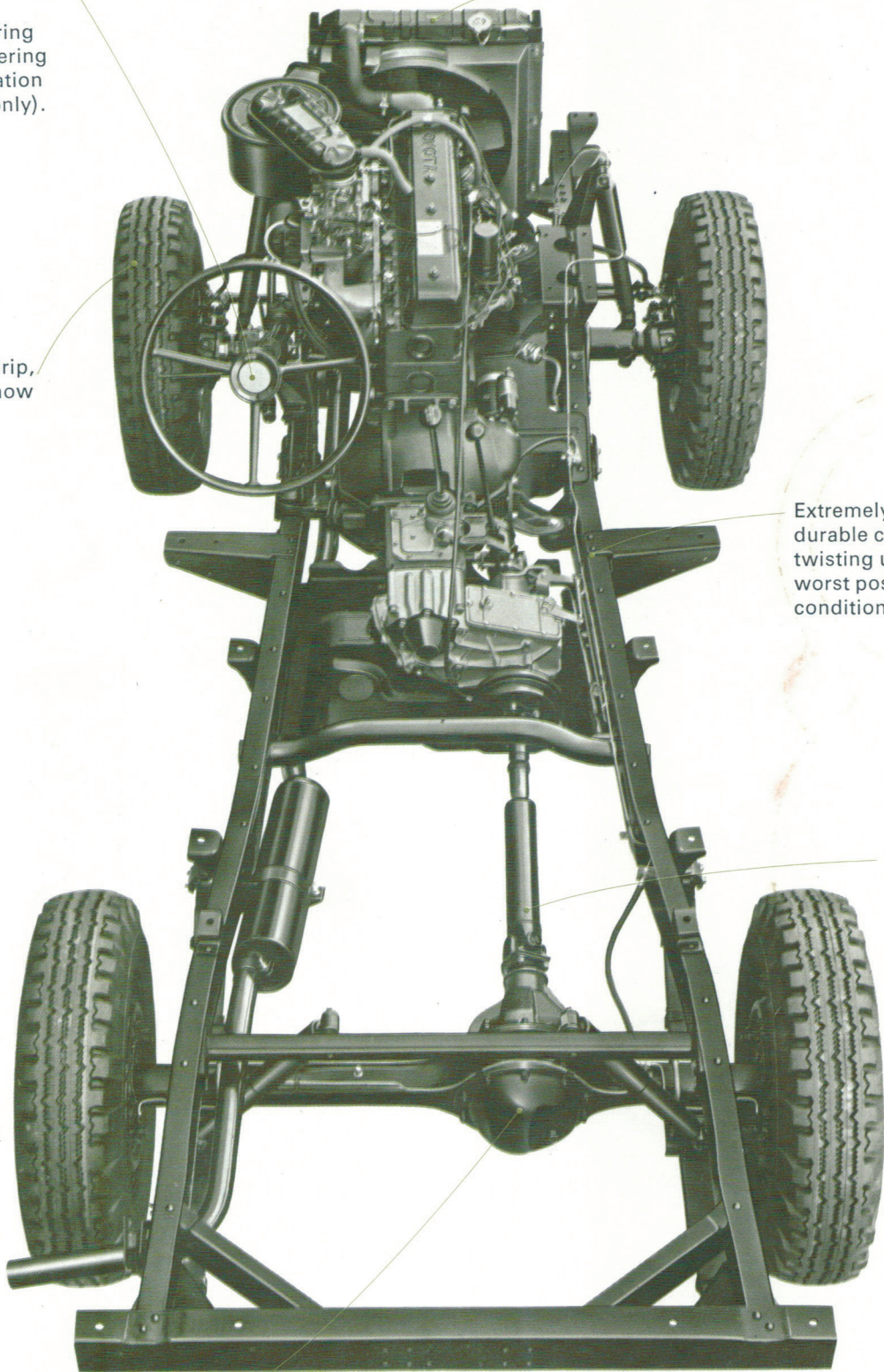

Un
to
lun
a t

Ru
on
eve
car
D

La
dr
hu
3
15
31
of
Th
re
dr
lo
en
po
ve
2-
co
ge
di
rat
co
the
the
ter
Al
wa
I
an
sy
Fr
wh
co
the
ell
do
ab
co
Fr
flo
dri
Re
ser
sp
an
co
an
Po
pu
op

Under its tough exterior lurks a tough heart

Rugged, powerful, long-lasting... every component can take it.

► **Durable engine:** Toyota Land Cruiser 4-wheel drive is equipped with a husky 6-cylinder OHV, 3878 c.c. (236.7 cu.in.)

engine that develops 155 HP at 4000 rpm and 31.7 m/kg. (230 ft.lbs.) of torque at 2200 rpm. This high output at slow revs. means greater driving comfort and longer engine life. The engine is equipped with positive crankcase ventilation system.

► **2-speed transfer case** combined with 3-speed gearbox provides 6 different gear speed ratios. This ideal combination will take the Land Cruiser through the worst conditions or terrain.

► **Alternator** 12-volt 480 watt alternator.

► **Powerful brake booster** and double circuit brake system (option).

► **Front suspension:** 4-wheel drive and steering components withstand the roughest use. Semi-elliptic leaf springs and double-acting shock absorbers give maximum comfort.

► **Front axle** is full-floating hypoid gear drive type.

► **Rear axle** is durable, semi-floating type. Leaf springs, shocks and antiroll bar ensure a safe, comfortable ride over any surface.

► **Powerful winch** for any pulling or lifting needs is optional equipment.

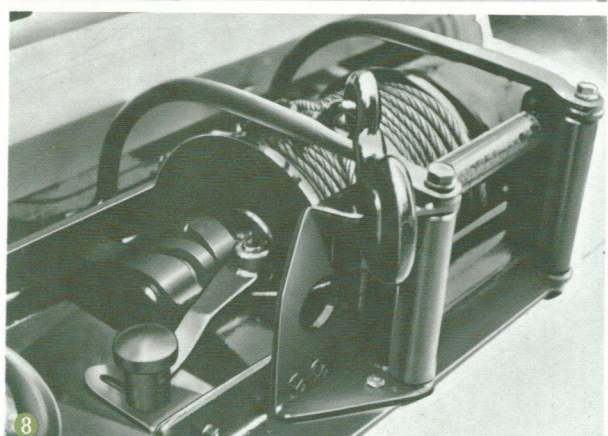
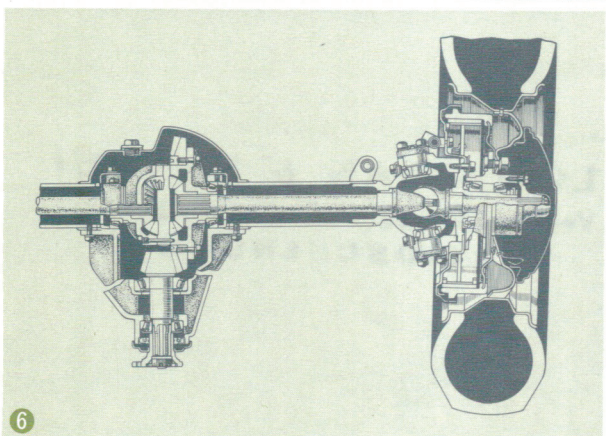
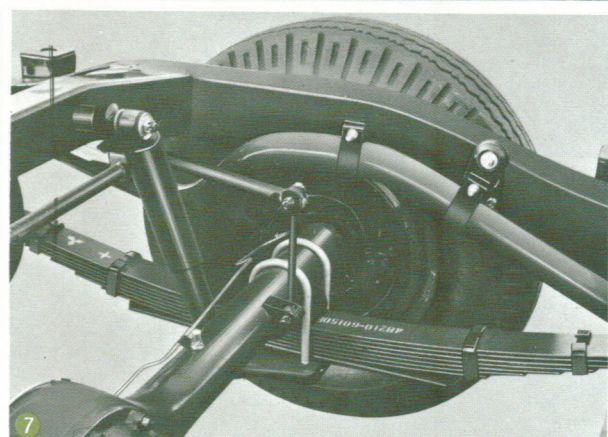
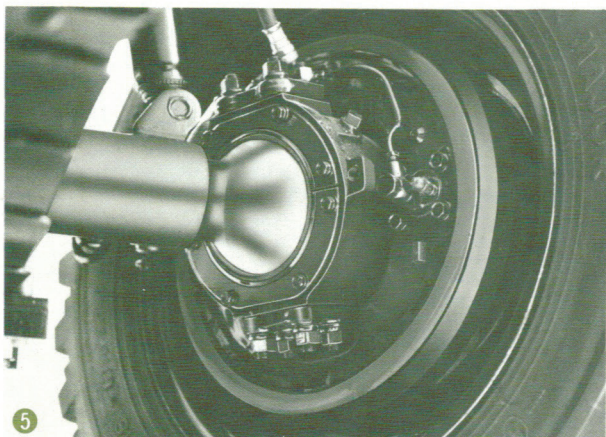
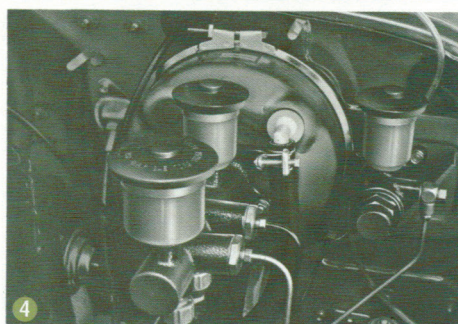
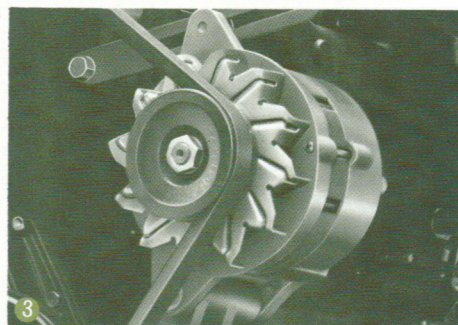
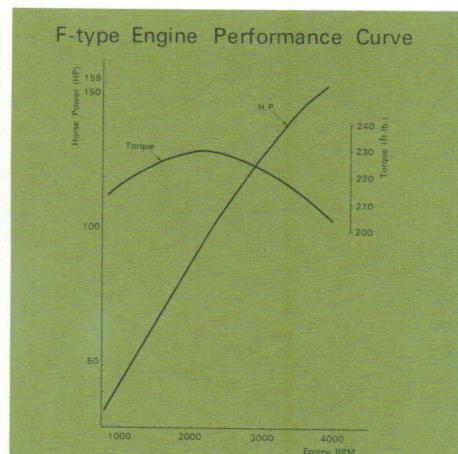
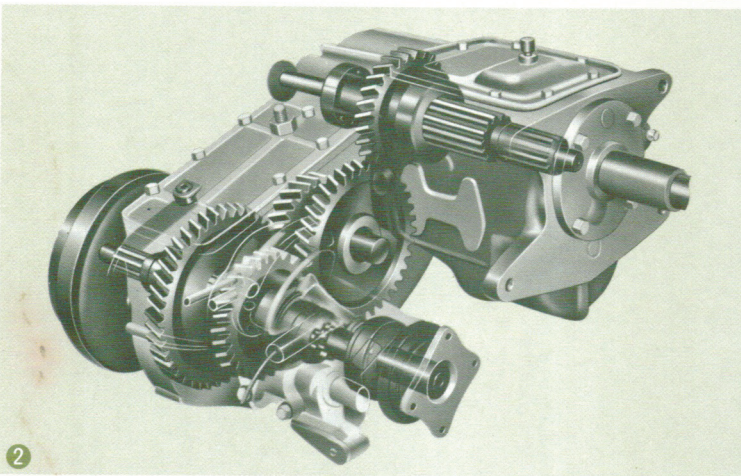
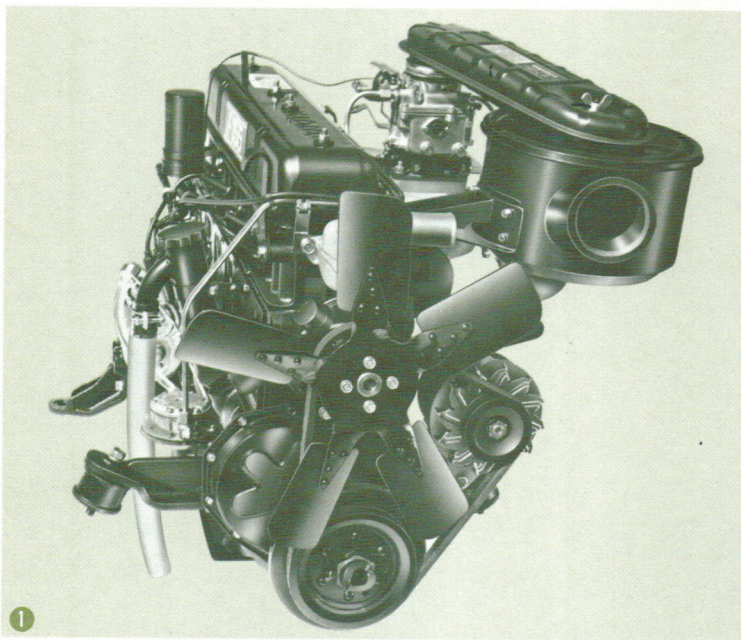

SPECIFICATIONS

Engine: 6-cylinder in line, OHV, 3,878 c.c. (236.7 cu.in.). Bore, 90 mm (3.54 in.). Stroke, 101.6 mm (4.00 in.). Compression ratio, 7.8 to 1. Maximum horsepower, 155 HP (SAE) at 4,000 rpm. Maximum torque, 31.7 m·kg (230 ft·lb) (SAE) at 2,200 rpm. 12-volt 50 amp.hr. battery. 12-volt 480 watt alternator. Down-draft 2-barrel carburettor with automatic choke. Fuel tank capacity; 70 litres (15.4 Imp.gal.), Station Wagon, 90 litres (19.8 Imp.gal.). Cooling system; Forced circulation by centrifugal pump. Lubrication system; Forced lubrication by gear pump. Water capacity; 15.2 litres (13.4 Imp.qts.). Engine oil capacity; 8.5 litres (7.5 Imp.qts.). Clutch: Dry single plate with torsion rubbers. Facing diameter, 275 mm (10.8 in.). Facing area, 716 sq.cm. (111.0 sq.in.).

Transmission: 3-speed, 2nd and 3rd gear synchromesh. Gear ratios; 1st, 2.757; 2nd, 1.691; 3rd, 1.000; Reverse, 3.676. Shift lever mounted centre floor.

Transfer: 2-speed helical gear sliding type. Ratio; Low, 2.31, High, 1.00.

Front axle: Full-floating, hypoid gear drive. Ratio; 3.70 (4.11 for FJ45PB).

Suspension: Front and rear; Semi-elliptic leaf springs and double-acting hydraulic telescopic shock absorbers.

Brakes: Hydraulic brakes operate on all wheels. Drum diameter; 290 mm (11.4 in.). Lining area; 1,180 sq.cm. (182.9 sq.in.). Parking brake; Mechanical brake operates on propeller shaft.

Steering: Worm and sector roller type. Gear ratio; 21:1.

Performance: Maximum speed; 125 km/h (80 mph.).

Inlet fuel strainer Fuel tank lock (std. on FJ55V) Spare fuel tank Pintle hook (except FJ45PB) Trailer socket (except FJ45PB) Body undercoating (std. on FJ55V) Heater/defroster Windscreen washer Alternator 480 W (low rev. charging) or 660 W Collapsible steering Column with steering lock (opt. on FJ55 RHD only) Seat adjuster (std. on FJ55V, FJ45PB) Front seat head restraints Additional parallel or transverse type rear seat Seatbelts Floor mat (std. on FJ55V) Fog lamps Hazard warning light switch Folding front windscreen (for FJ40, FJ43) Chrome bumper & grille Radio & antenna Short wave adapter Cigarette lighter Variations in tyre size and tread type Front-mounted winch Hi-power battery (12 V., 70 amp.hr.) Differential with gear ratio 4.11 (std. on FJ45PB) Brake booster (FJ40, FJ55 only) 4-speed floor shift type gearbox (full synchro) with two-speed transfer (FJ45PB, FJ55V only) Air conditioner (Optional on FJ55V only)

MAJOR ITEMS OF OPTIONAL EQUIPMENT

Starting handle (not available w/front winch, std. on FJ55V) Steel doors (for Vinyl Top model) Wheel caps (std. on FJ55V) Semi-stake and canvas hood for deck (for FJ45PB) Various Types of rear door on Vinyl Top

Hardtop

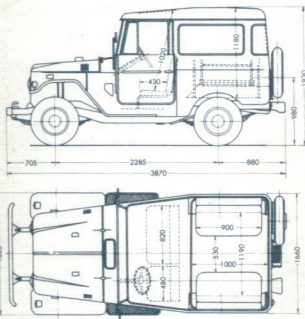

Vinyl Top

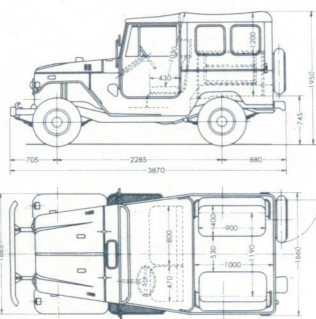

Station Wagon

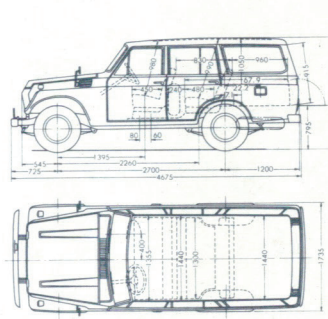

Pickup

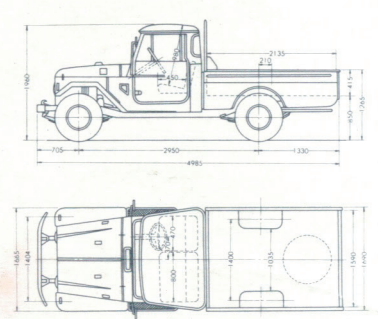

Dimensions			Vinyl Top (FJ40)	Hardtop (FJ40V)	Vinyl Top (FJ43)	Pickup (FJ45P-B)	Station Wagon (FJ55V)
Wheelbase		mm (in.)	2,285 (90.0)		2,430 (95.7)	2,950 (116.1)	2,700 (106.3)
Tread,	front	mm (in.)	1,404 (55.3)		1,404 (55.3)	1,404 (55.3)	1,405 (55.3)
	rear	mm (in.)	1,400 (55.1)		1,400 (55.1)	1,400 (55.1)	1,400 (55.1)
Overall,	length	mm (in.)	3,870 (152.4)		4,230 (166.5)	4,985 (196.3)	4,675 (184.0)
	width	mm (in.)	1,665 (65.6)		1,665 (65.6)	1,690 (66.5)	1,735 (68.7)
	height	mm (in.)	1,950 (76.8)	1,930 (76.0)	1,970 (77.6)	1,960 (77.2)	1,865 (73.4)
Ground clearance		mm (in.)	200 (7.9)		210 (8.3)	230 (9.1)	210 (8.3)
Net vehicle weight		kg. (lb.)	1,480 (3,265)	1,575 (3,470)	1,590 (3,505)	1,720 (3,790)	1,800 (3,970)
Gross vehicle weight		kg. (lb.)	2,050 (4,500)	2,050 (4,500)	2,300 (5,000)	2,900 (6,400)	2,600 (5,700)
Tyre size (standard)	front		7.10-15, 4 P.R.		7.60-15, 4 P.R.	7.00-16, 6 P.R.	7.00-15, 6 P.R.
	rear		7.10-15, 4 P.R.		7.60-15, 6 P.R.	7.00-16, 8 P.R.	7.00-15, 6 P.R.
Turning circle		m (ft.)	10.6 (35.0)		11.0 (36.0)	13.2 (43.0)	12.4 (41.0)

The right is reserved to alter prices and any details of specifications and equipment without notice. Details of specifications and equipment are subject to change to suit local conditions and requirements.

Importeur voor Nederland

LOUWMAN & PARQUI

Veursestraatweg 280 - Tel. 01761 - 6911

LEIDSCHENDAM

TOYOTA TOYOTA MOTOR CO., LTD. TOYOTA MOTOR SALES CO., LTD.

FJ/E-69/®/Printed in Japan No. 88920